

# Dual-Range Force Sensor Air Track Adapter

(Order Code ATA-DFS)

This adapter allows the Dual-Range Force Sensor to be mounted on the end of an air track for collision studies. It is compatible with most air tracks distributed or made by PASCO scientific, Central Scientific, or Daedalon Corporation. Using our computer-based or calculator-based data collection and analysis equipment, you may plot the collision data. Integrate the force-time data to obtain impulse and compare to the momentum change of the air track glider.

The Dual-Range Force Sensor Air Track Adapter was designed by Bruce Lee of Andrews University and is manufactured by A.U. Physics Enterprises.

**NOTE:** This product is to be used for educational purposes only. It is not appropriate for industrial, medical, research, or commercial applications.

## What is included with the Air Track Adapter?

- Aluminum bracket with decal and track mounting hardware (two nylon bolts). Attach the bracket to the air track using either the two included bolts or the accessory attachment bolts for your air track.



- Magnetic bumpers (2 aluminum brackets with 2 magnets permanently mounted to each).  
**NOTE:** These are very **STRONG** permanent magnets. Keep away from objects that may be affected by strong magnetic fields.

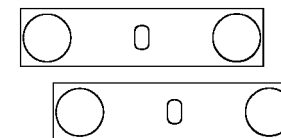

- Nylon thumbscrew to secure magnetic bumper to force sensor



- Nylon thumbscrew and nut to secure magnetic bumper to u-shaped glider bracket.

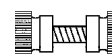

- Larger nylon thumbscrews for securing adapter bracket to air track.

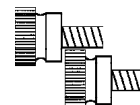

- Four 10-24 x 3/8 screws for attaching u-shaped bracket to Daedalon or Central Scientific glider.

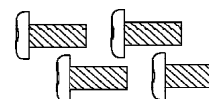

- U-shaped bracket for Daedalon or Central Scientific glider.

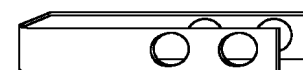

- U-shaped bracket for PASCO glider.

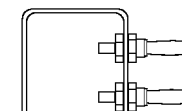

Vernier Software & Technology  
13979 S.W. Millikan Way  
Beaverton, OR 97005-2886  
(503) 277-2299 • FAX (503) 277-2440  
info@vernier.com • www.vernier.com

## How to use the Air Track Adapter

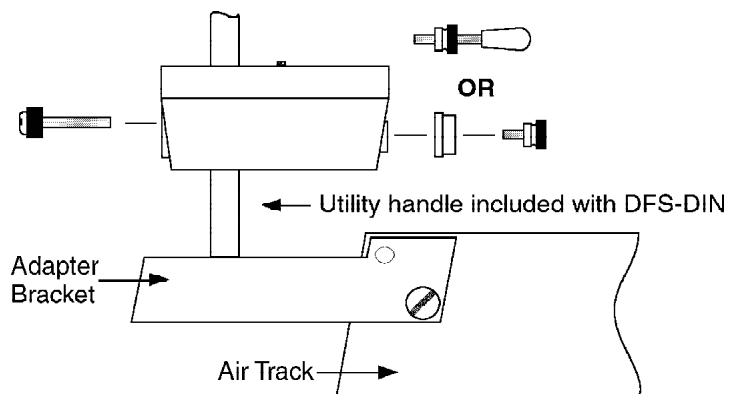

Attach the bracket to the end of the air track with the short nylon screws that came with the Air Track Adapter or with the accessory screws supplied with the air track. Thread the utility handle that came with your Dual-Range Force Sensor into the nut on the top surface of the adapter. Secure the DFS to the rod using the nylon screw that came with the DFS. Adjust the height to match the collision location on the target. Use either the collision bumper (supplied with the DFS) or the magnetic bumper (supplied with the Air Track Adapter).

Use the U-shaped adapter and nylon thumbscrew/nut to secure the magnetic bumper to the air track glider. For PASCO gliders, use the bracket with two banana plugs. For Central Scientific & Daedalon gliders, use the long bracket and four 10-24 screws. Alignment of the magnetic bumpers is critical. The magnets on the DFS should be 1-2 mm higher than the glider magnets for best results.

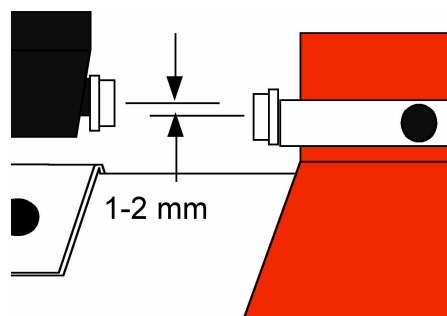

## Other Adapters for the Vernier Dual-Range Force Sensor

### Dynamics Track Adapter (DTA-DFS, \$46)

This adapter extends the versatility of your force sensor by increasing the mounting possibilities. It is specifically designed to attach to a PASCO Dynamics Track. Multiple mounting options allow for sensor-to-sensor or sensor-to-cart collision measurements. Includes two magnetic bumper attachments.

### Force Table Adapter (FTA-DFS, \$25)

Use your Dual-Range Force with your force table for resolution of vector experiments. Includes mounting clamp for tables up to 3/4 inch thick.