

# Data Display and Acidity Tester

## OVERVIEW

Manufacturers use robots to do tasks that might be harmful to people. One common example of such a task is working with hazardous materials. A hazardous material is one that could cause harm to human health or to the environment. Many common household solutions, such as paints, cleaners, inks, and dyes, can be considered hazardous. Acids are sometimes considered a hazardous chemical because they can cause severe burns if they gets in your eyes, nose, or skin. However, not all acids are strong enough to be hazardous. Acids such as vinegar and lemon juice are used in cooking to give foods distinctive flavors.

Solutions that have a pH of less than 7 are acidic. neutral solutions have a pH of 7. If a solution has a pH of greater than 7, it is considered basic.

## PART 1 DATA DISPLAY

Many of the projects in this book will require you to have some means of reading the sensor value of the Vernier probe or sensor that you are using. There are a couple of ways to do this:

- Download and run a program with the EV3 brick connected to your computer. You can see an instantaneous reading of the sensor if you move your cursor over the wire coming from the numerical value.

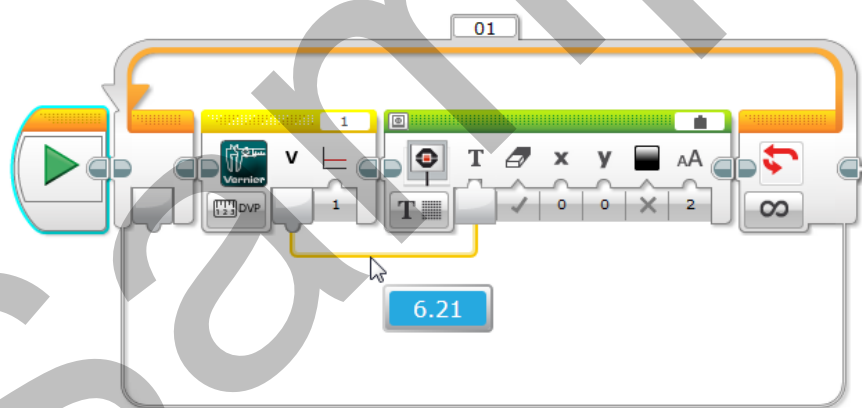

Figure 1

- The other option is to write a simple program to display the data on the EV3 screen, itself. This is useful because you can see the readout even when the robot is not connected to the computer. A program of this type frequently comes in handy when conducting scientific investigations or when you need to determine a sensor value for a more complex program. As this is such a valuable program to know how to build and modify, we suggest that you follow the procedure in the next section in order to create your first Data Display program. You may find yourself using such a program several times as you work through the different projects in this book.

## How to Create a Data Display

Connect a Vernier sensor to the BTA socket on the end of the adapter, and use a LEGO® cable to connect the other end to any port on the EV3. In this example we used the Gas Pressure Sensor, but you can create a data display for any of the sensors used in this book.

In order to display data from a Vernier sensor on the EV3 screen, create the following program and download it to the brick.

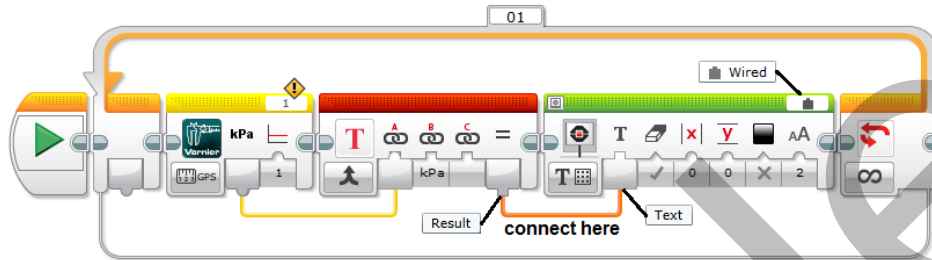

*Figure 2 Program to display sensor measurements with units*

To create this program, drag a Loop block (found in the Flow Control palette) onto the programming canvas. Since you want the program to continuously display data values, keep the default mode of Unlimited repetitions. To stop this program, press the Back button on the EV3.

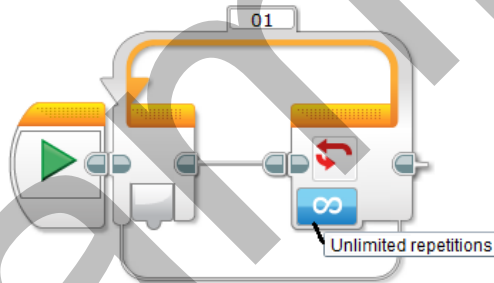

*Figure 3 Configuration settings for a Loop block*

Next, drag a Vernier block (found in the Sensor palette) inside the Loop. You can choose from a variety of sensor measurement options in the drop-down list. Set Oversampling to 1 (On). If you do not choose oversampling, the readings may come too fast, and you might not be able to read them on the display. Make sure to select the port number that matches the port into which you connected the NXT Sensor Adapter.

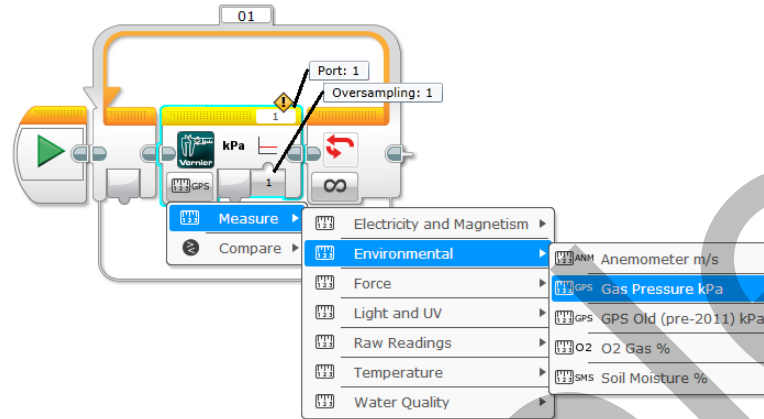

*Figure 4 Vernier sensor selection from a drop-down list*

When you select a sensor from the drop-down list on the Vernier block, the sensor's corresponding unit is displayed on the block (see the circle around kPa on the Vernier block in Figure 5 for an example). However, only numerical values are output from the block.

In order to merge the numerical value and units into a single text string that can be displayed on the EV3 screen, drag a Text block (found in the Data Operations palette) inside the Loop and to the right of the Vernier block. Connect the Numerical Value from the Vernier block to the “A” input on the Text block. Type the corresponding unit into the “B” input.

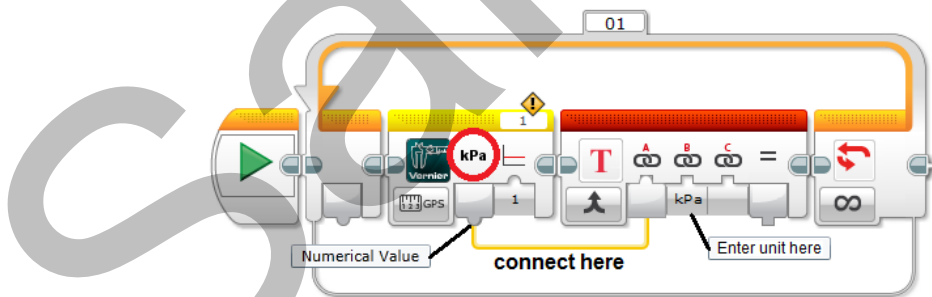

*Figure 5 Add units to a sensor measurement with a Text block*

## Project 1

The final step in the program is to drag a Display block to the right of the Text block. Set the mode to Text ► Grid, and select Wired from the upper-right corner. Connect the Result output from the Text block to the Text input on the Display block.

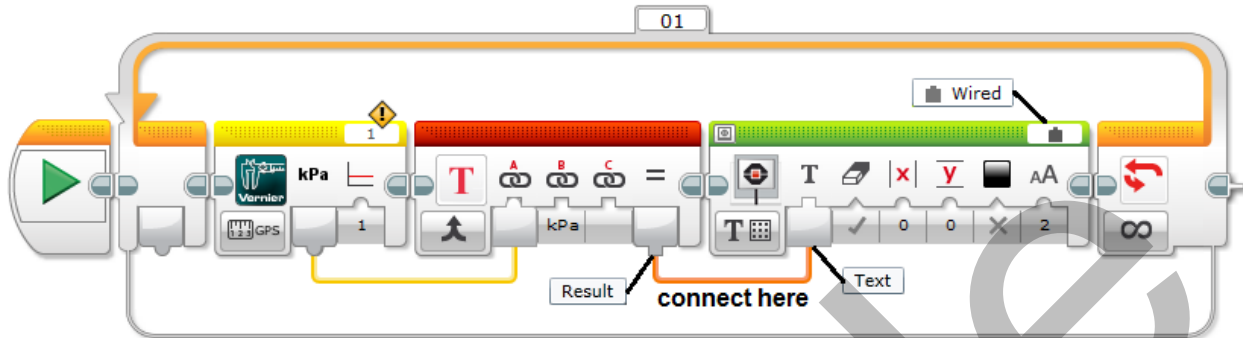

Figure 6

Now that you know how to display your data on the EV3 screen, modify the program to display readings from the pH Sensor. Note that you will need to change the selected sensor in the Vernier block and the units in the Text block. Take a few readings with the sensor to confirm that the hardware and software are working properly. This will get you ready for the next part of this activity.

## PART 2 ACIDITY TESTER

### Design Requirements

Your challenge is to design and build an automated device to determine if a liquid is acidic or non-acidic. The robot should be free-standing and may be mobile. Incorporate a Vernier pH Sensor into your design to test the acidity of several common household solutions. The user will place the container with the liquid to be tested close to the robot, but the robot must automatically insert and retract the sensor. The robot must provide some type of feedback to the user to let them know if the solution is acidic or non-acidic (neutral or basic).

## **Materials**

- Vernier pH Sensor
- Vernier NXT Sensor Adapter
- sturdy cup (e.g., coffee cup)
- household solutions (see Sensor Notes)
- wash bottle filled with distilled water

## **Tips**

- The tip of the pH Sensor is fragile. Avoid striking it on the edge or bottom of the cup.
- Place the pH Sensor in a pH 7 buffer solution when not in use to keep it from drying out. Return the sensor to its original container for long-term storage.
- To ensure good readings, rinse the tip of the sensor with distilled water between pH tests.
- Use a ceramic coffee cup or other relatively heavy container to hold your test liquids, because a lightweight container (such as a foam cup) might tip over.

## **Sensor Notes**

The pH Sensor is designed to take measurements in the range of 0 to 14. It comes with a storage bottle filled with a pH 4 buffer/KCl solution. Before taking measurements, remove the sensor from the storage bottle, and rinse the lower section of the probe with distilled water. Take care during use to keep the bulb-shaped end of the sensor (the electrode) moist so it does not dry out.

Use orange juice, cola, vinegar, or lemon juice for the acid solutions and mild detergent or baking soda with a little water added to it for the non-acidic solutions. Do not use other solutions without supervision and safe handling instructions from your teacher as they can be irritating to the skin, eyes, lungs, or mucous membranes.

TEACHER INFORMATION

# Data Display and Acidity Tester



*Figure 1*

Part I of the student section guides students through the process of creating a program to display sensor readings on the EV3 screen. Students will find this knowledge helpful during other projects when they are troubleshooting to set appropriate parameters in their programs.

In Part 2, students may find it useful to experiment with a pH Sensor attached to the EV3 brick running the Data Display program prior to attempting to build and program their acidity tester.

In this teacher information, you will find all the information that is presented in the student pages in addition to some extra information that you may find helpful. Our programming solution for this project uses a Switch block to indicate if the liquid is acidic or non-acidic.

## PART 1 DATA DISPLAY

There is no formal construction required for this project. If desired, you can connect the NXT Sensor Adapter to the side of the EV3 screen using two black pegs. Connect a Vernier sensor to the BTA socket on the end of the adapter, and use a LEGO cable to connect the other end to any port on the EV3.

To display data from a Vernier sensor on the EV3 brick, create the program in Figure 2 and download it to the brick.

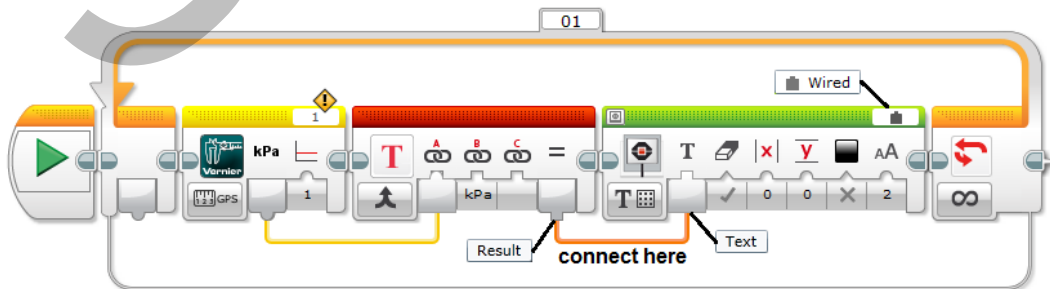

*Figure 2 Program to display sensor measurements with units*

## Project 1

To create the program in Figure 2, drag a Loop block (found in the Flow Control palette) onto the programming canvas. Since you want the program to continuously display data values, keep the default mode of Unlimited repetitions. To stop this program, press the Back button on the EV3 Brick.

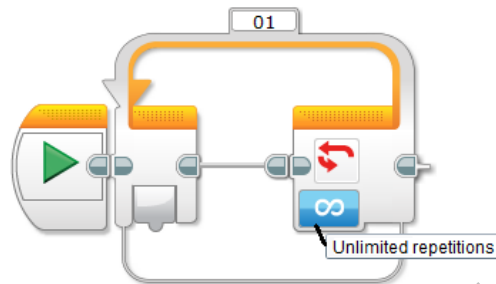

Figure 3 Configuration settings for a Loop block

Next, drag a Vernier block (found in the Sensor palette) inside the Loop. You can choose from a variety of sensor measurement options in the drop-down list. Sensors with multiple ranges or sensitivities are shown as separate entries in the list. Set Oversampling to 1 (On). *Oversampling* is a technique for improving accuracy and minimizing noise in the sensor signal by averaging multiple sensor readings over a half-second period. If you do not choose oversampling, the readings will come too fast and you might not be able to read them on the display. In this case, you would have to add a Wait block in the code to slow the readings. Make sure to select the port number that matches the port into which you connected the NXT Sensor Adapter.

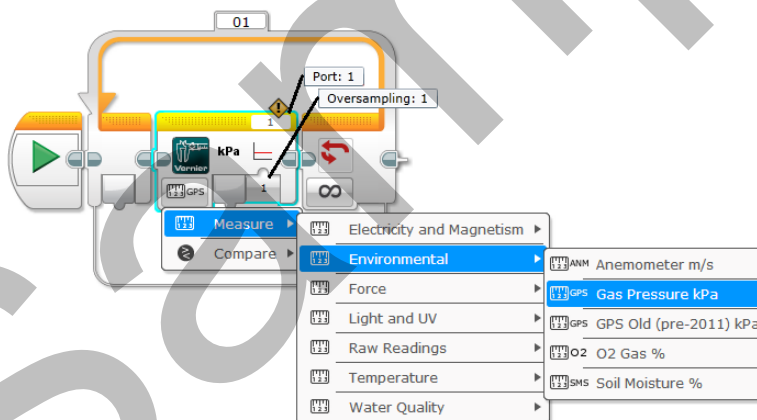
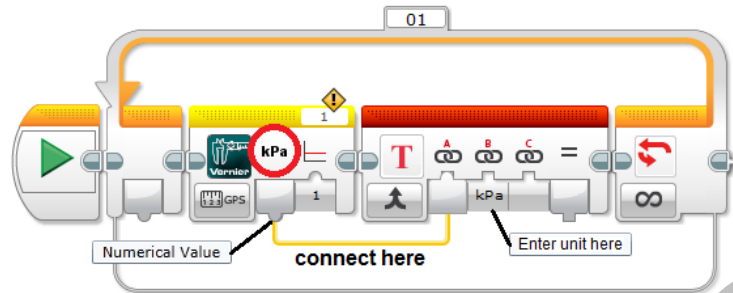

Figure 4 Vernier sensor selection from a drop-down list

When you select a sensor from the Vernier block drop-down list, the corresponding unit is displayed on the block (see the kPa circled in Figure 5); however, only numerical values are output from the block. In order to merge the numerical value and units as a single text string that can be displayed on the EV3 screen, drag a Text block (found in the Data Operations palette) inside the Loop to the right of the Vernier block. Connect the Numerical Value from the Vernier block to the “A” input on the Text block. Type the corresponding unit into the “B” input.

Note that the Text block expects a text data type as an input, but that the Vernier block output is a numeric data type. This works because in this instance, the MINDSTORMS® software

performs an automatic conversion from one data type to another. A conversion from numeric to text is one of these automatic conversions.



*Figure 5 Add units to a sensor measurement with a Text block*

The final step in the program is to drag a Display block to the right of the Text block. Set the mode to Text ► Grid, and select Wired from the upper-right corner. Connect the Result output from the Text block to the Text input on the Display block.

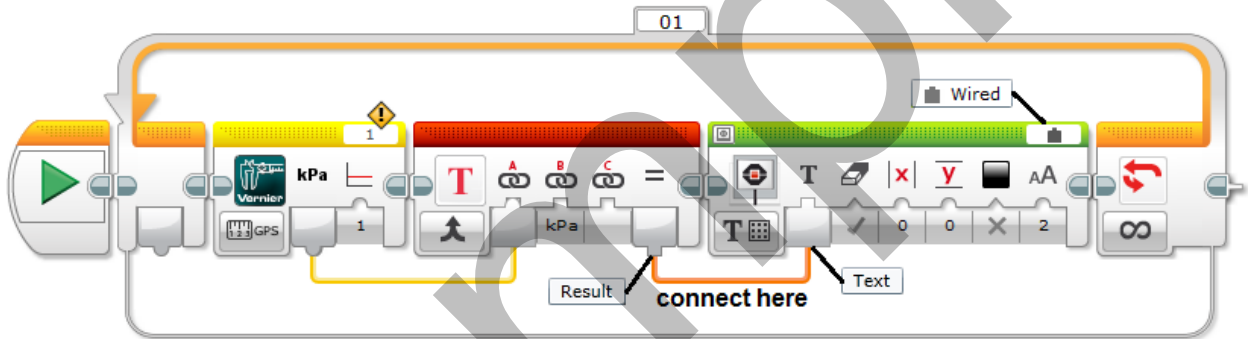

*Figure 6*

Download and run this program to see live readings from your sensors displayed on the EV3 screen. If you change sensors, make sure to modify the program.

## **EXTENSIONS**

1. Add more text to your display. For example, if you are measuring temperature and it is reading 23 Celsius, the display would read "The Temperature is 23 Celsius."
2. Modify the size and the location of the text on the display.
3. Some sensors, such as the Temperature Probe, have the ability to display readings in multiple units (°C or °F). Modify your program to allow the user to choose which units they would like to see.



## **PART 2 ACIDITY TESTER**

### **CONSTRUCTION**

In this project, students need to design a device to automatically determine if a liquid is acidic or non-acidic using a pH Sensor. One idea is to build a motorized gearing mechanism to vertically lift and lower the sensor into a coffee cup. Since the tip of the sensor is fairly fragile, tell students to take extra care when testing their design to ensure that the gel-filled bulb does not strike the edge or bottom of the cup.

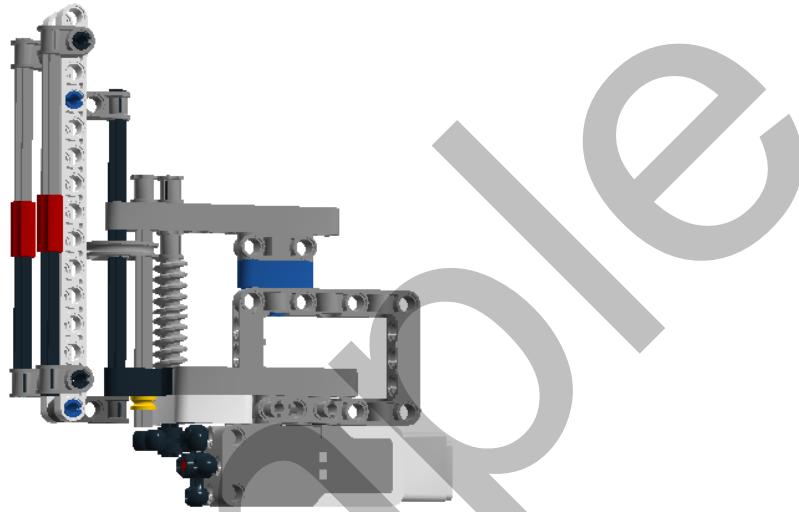

*Figure 7 Gearing mechanism for lowering a pH Sensor*

This device uses two worm gears and a wedged belt wheel to lift and lower the sensor. In our model, we attached the device to the side of the EV3 Educator Vehicle Driving Base. Building instructions for the Driving Base can be found in the Robot Educator section of the MINDSTORMS<sup>®</sup> software lobby. Attaching the mechanism to the Educator Vehicle ensures that the sensor is positioned high enough to allow you to place a standard coffee cup underneath it. It also gives you the flexibility to use the same device for this project and the extensions that follow. Insert the pH Sensor between the front axles and secure it in position with rubber bands. Connect the sensor to the Vernier NXT Adapter, and then connect the adapter to Port 1 on the EV3.

The gearing mechanism and holder for this robot can be found as a .lxf file on the accompanying CD. This file can be opened with LEGO<sup>®</sup> Digital Designer software, allowing you to view the entire model, the parts, and the building instructions.

### **PROGRAMMING**

A sample program to test household solutions is shown in the Figure 8. The program uses a Vernier pH Sensor to determine whether the liquid is acidic or non-acidic.

The general approach of the program is to lower the pH sensor into the solution, read the sensor, give a audible signal if it is acidic or not, and then lift the sensor. There is a pause built in to allow the sensor reading to stabilize while in the liquid.

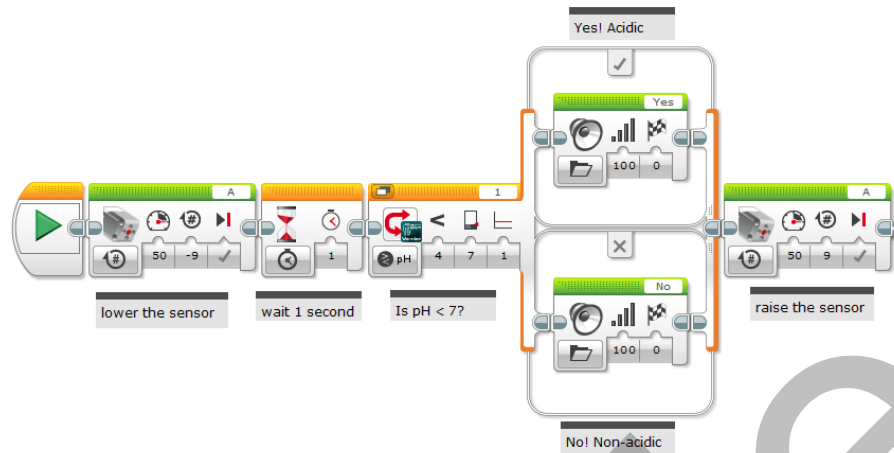

Figure 8 Sample program for an Acidity Tester

Your first action is to lower the pH sensor into the cup. If you are using the medium motor for your gearing mechanism, drag a Medium Motor block (found in the Action palette) onto the programming canvas. Set the mode to On for Rotations, the Power to 50, and the Rotations to -9. For this design, a negative number of rotations lowers the probe and a positive number of rotations raises it. You may need to reverse the positive and negative signs to accommodate your design.

Drag a Wait block (found in the Flow Control palette) to the right of the Medium Motor block, and set the number of seconds to 1. The pause in the program gives the pH Sensor time to come to equilibrium before taking a reading.

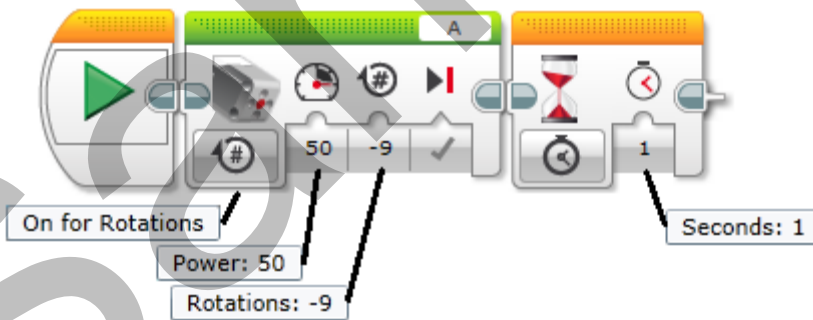

Figure 9 Configuration settings for lowering a sensor and pausing

A Switch block is useful when making comparisons. In this case, when the sensor reading indicates the liquid is an acid it will cause the EV3 brick to respond "yes." If the liquid is not acidic, it will respond "no." Drag a Switch block (found in the Flow Control palette) to the right of the Wait block. Set the mode to Vernier ► Compare ► Water Quality ► pH. Set the comparison type to 4 (Less Than), enter a Threshold Value of 7, and set Oversampling to 1 (On). *Oversampling* is a technique for improving accuracy and minimizing noise in the sensor signal by averaging multiple sensor readings over a half-second period. Oversampling is not necessary, but it will result in more stable pH readings. Make sure the port number matches the port into which you connected the sensor. Drag Sound blocks (found in the Action palette) into the True and False cases of the Switch block. The True case will indicate that the solution is acidic, while

## Project 1

the False case will indicate that the solution is non-acidic. Choose appropriate sound files for both cases. In this example the robot says "yes" when the pH is less than 7 (acidic), otherwise it says "no."

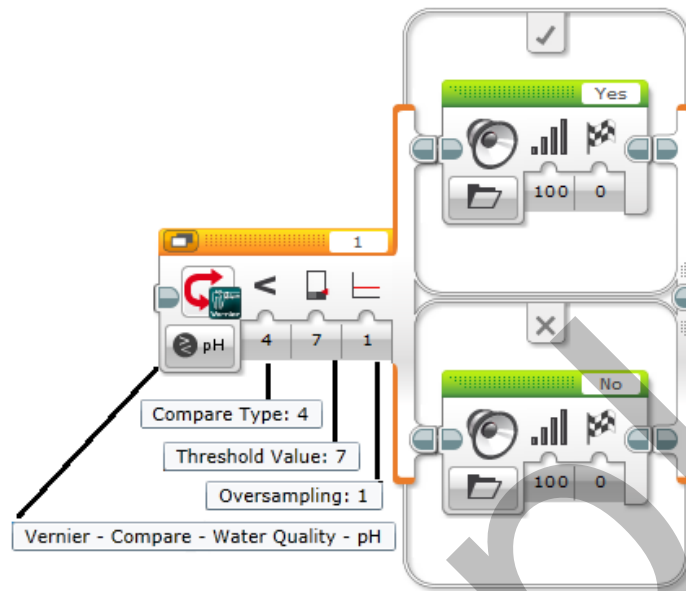

Figure 10 Configuration settings for determining if pH is acidic

The final step in the program is to raise the pH sensor out of the cup. Drag a second Medium Motor block to the right of the Switch block. Set the mode to On for Rotations, the Power to 50, and the Rotations to positive 9.

## EXTENSIONS

1. Liquids have other properties that can be considered potentially hazardous to humans or other living organisms, such as excessive temperature, conductivity, or salinity. Modify your robot to use a Vernier Stainless Steel Temperature Probe to test for scalding liquids, use a Vernier Conductivity Probe to check for a heavy ion concentration, or use a Vernier Salinity Sensor to detect brine.
2. Make the robot mobile so that it approaches the cup, senses that it is in place using a touch sensor, and lowers the pH sensor into the liquid.
3. (Very challenging) Outline two rectangular areas on the floor with dark tape and label them "acid" and "base." Build a mobile robot with a LEGO Light or Color Sensor that can sort a set of liquid-filled cups into the two areas using a line-detection algorithm. Liquids with a pH less than 7 will go into the acid section, while liquids with a pH of 7 or greater will go into the base section.